

Basic Electrical House Wiring

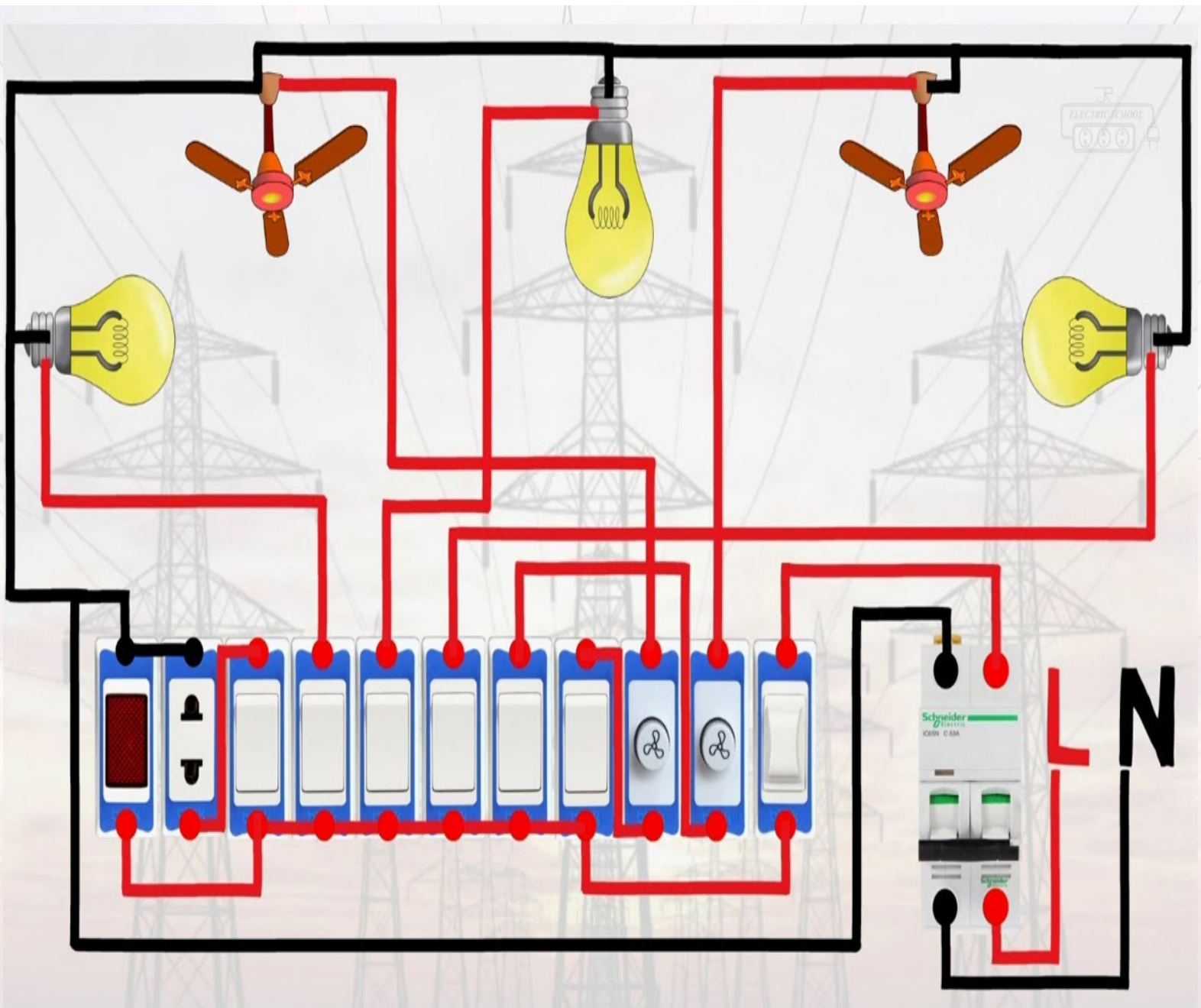

Contents...

1. Basic Symbols of Electricity
2. Rules of Safety of Electricity
3. Electrical Devices
4. Electrical Tools.....
5. Electrical Wire Joints.....
6. Electrical Surface Wiring.....
7. PVC Cable and Insulated tape.....
8. Switches.....
9. Devices of measuring of Electricity.....
10. Practical questions with connect

1. Basic symbols of Electricity

Filament bulb



Piano Fuse (5Amp)



Piano Switch (5 Amp)

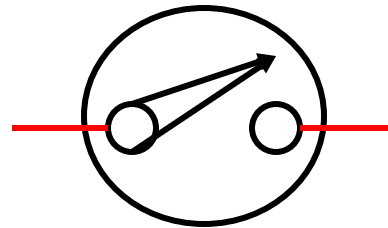

Tumbler Switch (15 Amp)

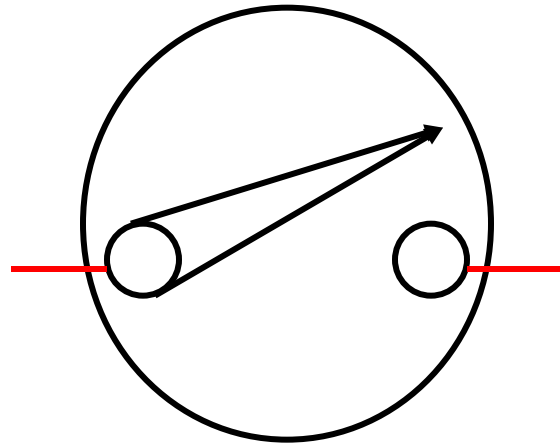

Piano Socket (5 Amp)

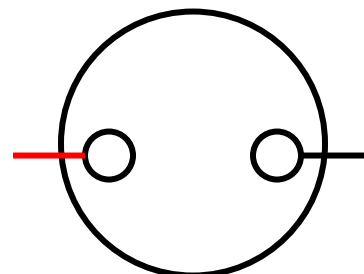

Tumbler Socket (15 Amp)

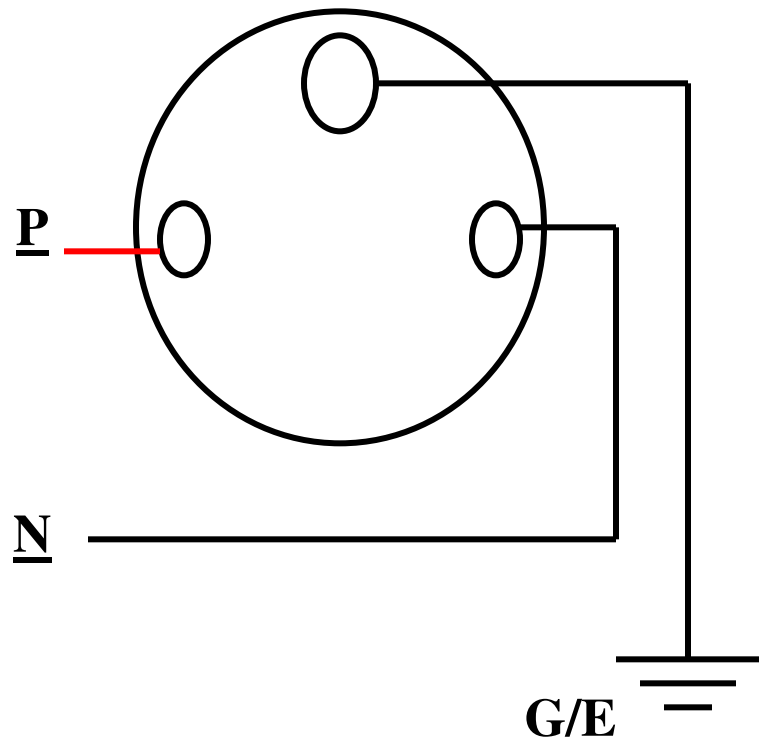

Batten Holder

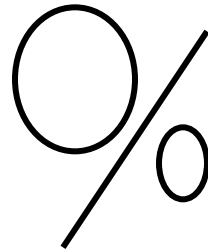

Ceiling Rose

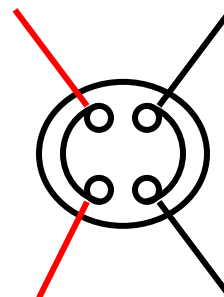

Indicator Lamp

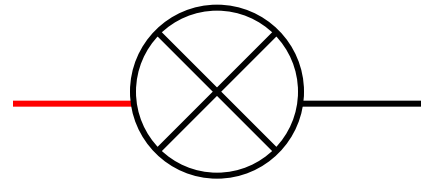

Tube Light

16w T4 Fluorescent Tube

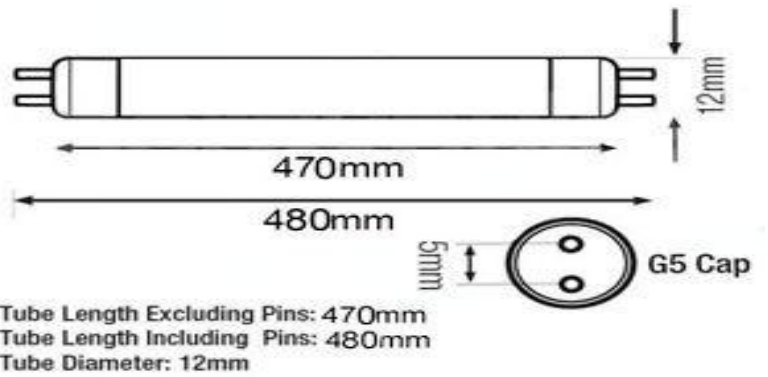

Six pin combined socket

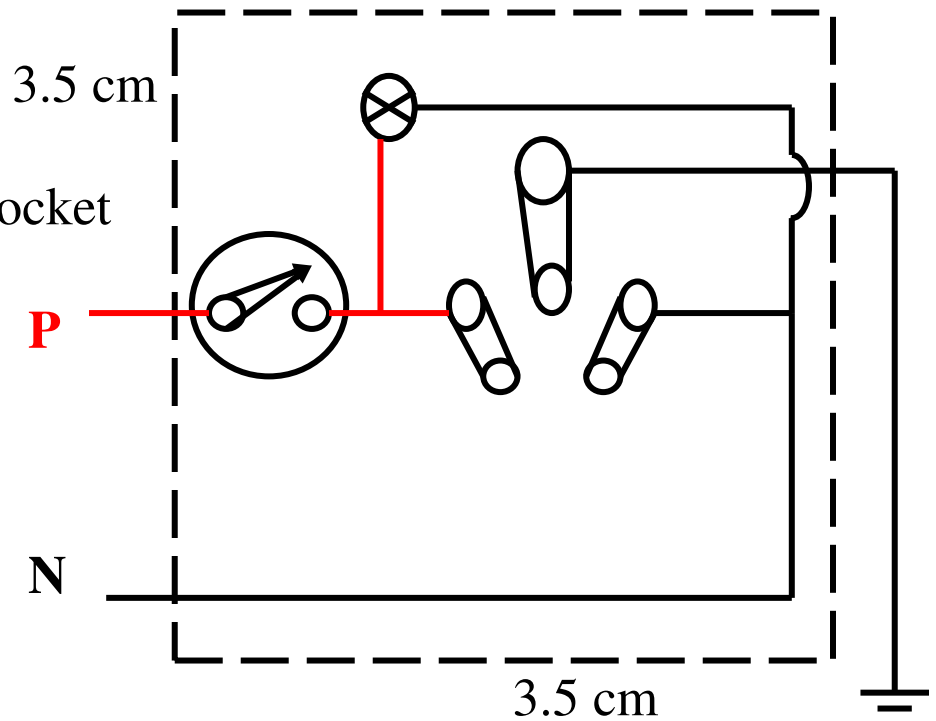

Tube light Ballast



Cable Joint

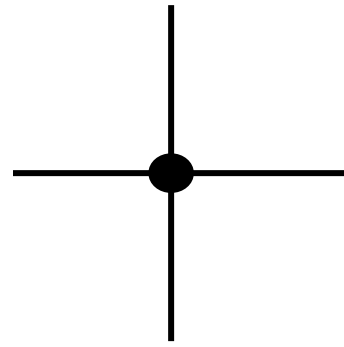

20mm

Fan Regulator

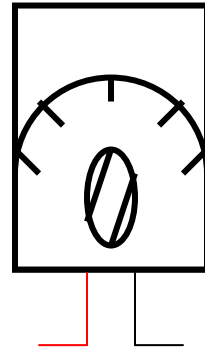

25mm

Calling Bell

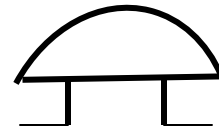

Tube light Starter

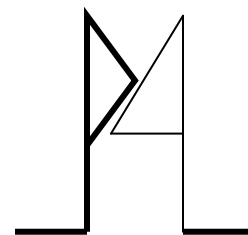

Push Switch

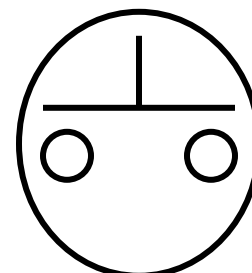

Intermediate Switch

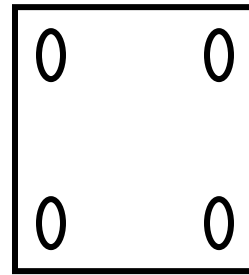

Two-way Switch

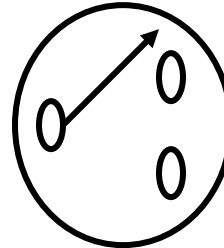

Two pin plug

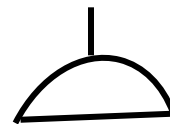

Tree pin plug

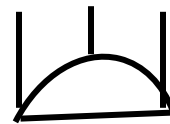

Ceiling fan

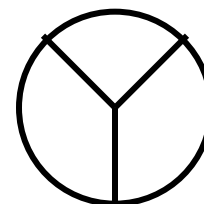

Cable Crossing point

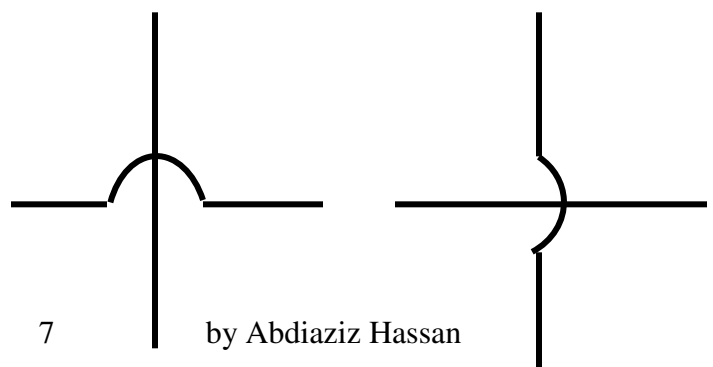

Main distribution Board

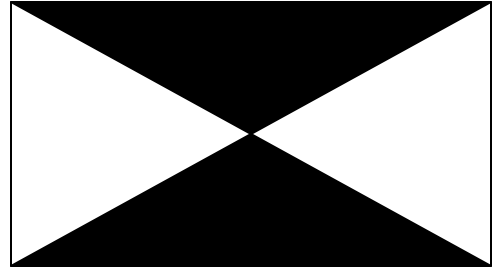

Sub-Main distribution Board

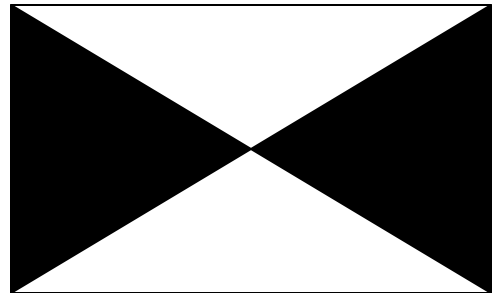

Distribution Board

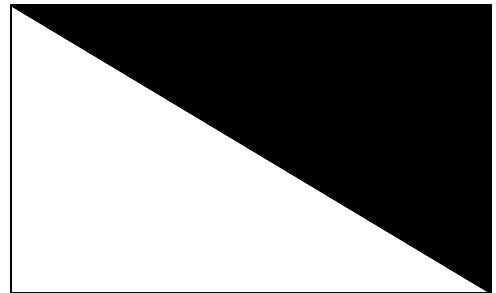

Sub-Distribution Board

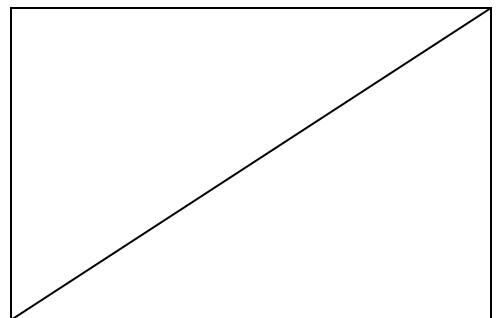

Switch Board

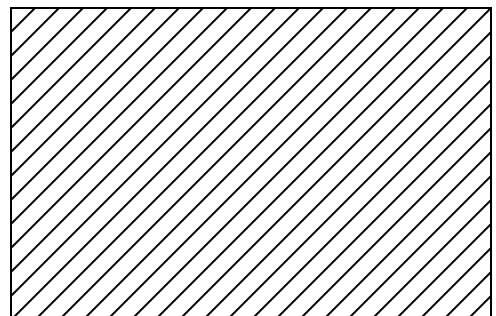

A **distribution board** (also known as **panel board** or **breaker panel**) is a component of an **electricity supply system** which divides an electrical power feed into subsidiary **circuits**, while providing a protective **fuse** or **circuit breaker** for each circuit in a common **enclosure**. Normally, a main **switch**, and in recent boards, one or more **residual-current devices** (RCD) or **residual current breakers with over current protection** (RCBO), are also incorporated.



Distribution boards are also referred to as a:

- breaker panel
- circuit breaker panel
- **consumer unit**, or CU
- electrical panel
- fuse board
- electric board
- Fuse box.
- breaker box
- load centre/center
- panel board
- power breaker
- service panel
- DB board (South Africa)
- ACDB (alternating current distribution board)
- DCDB (direct current distribution board)

Wiring of the Distribution Board With RCD (Single Phase) Consumer Unit (From Energy Meter to the Main Distribution Board)

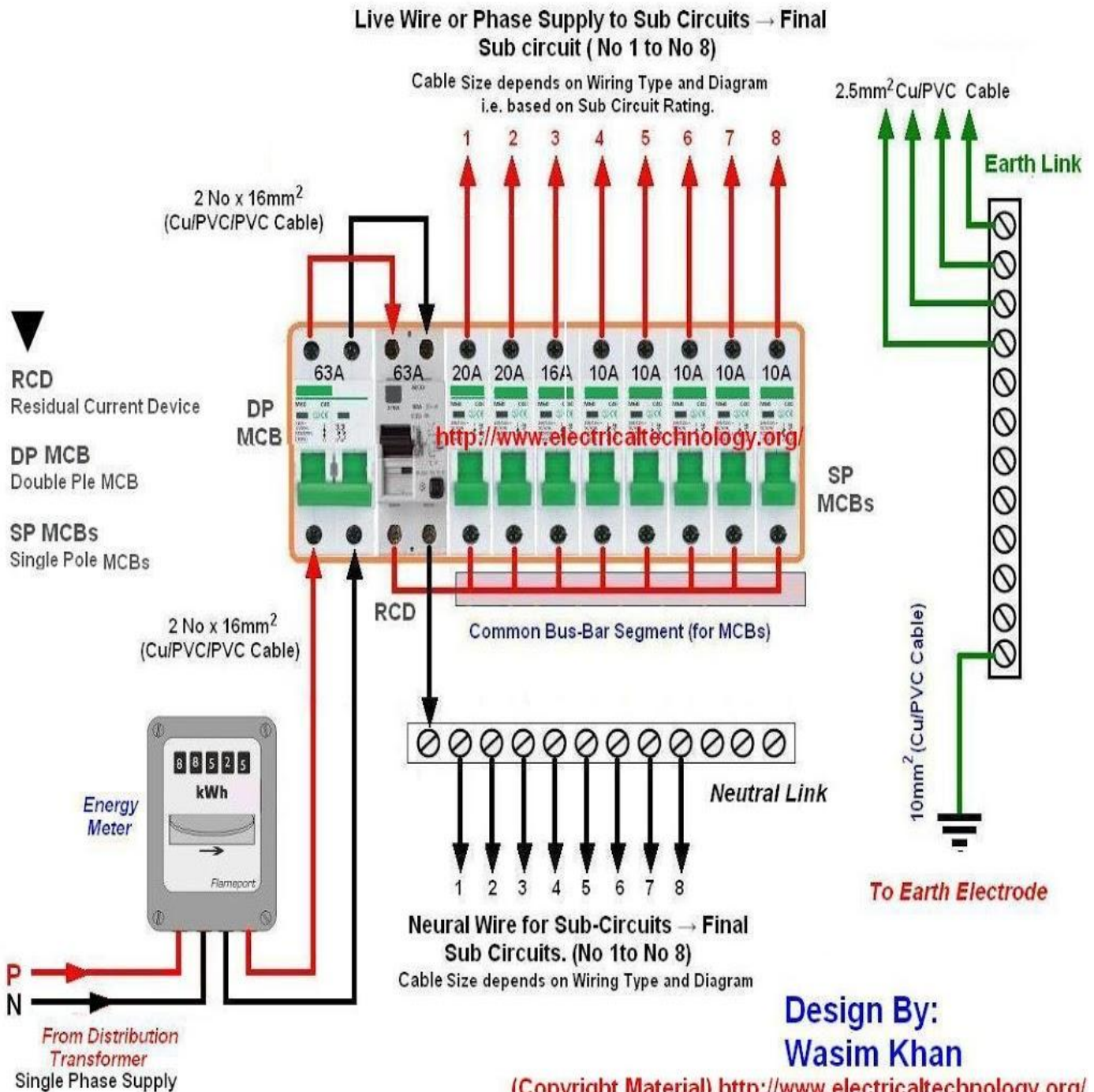

Type of breakers based on number of pole:

Based on the number of poles, the breakers are classified as

1. SP MCB– Single Pole
2. DPMCB – Double Pole
3. SPN – Single Pole and Neutral
4. TPMCB – Triple Pole
5. TPNMCB – Triple Pole and Neutral
6. 4P – Four Pole

1. SP (Single Pole) MCB:

In Single Pole MCCB, switching & protection is affected in only one phase.

Application: Single Phase Supply to break the Phase only.

2. DP (Double Pole) MCB:

In Two Pole MCCB, switching & protection is affected in phases and the neutral.

Application: Single Phase Supply to break the Phase and Neutral.

3. TP (Triple Pole) MCB:

In Three Pole MCB, switching & protection is affected in only three phases and the neutral is not part of the MCB.

3pole MCCB signifies for the connection of three wires for three phase system (R-Y-B Phase).

Application: Three Phase Supply only (Without Neutral).

4. TPN (3P+N) MCB:

In TPN MCB, Neutral is part of the MCB as a separate pole but without any protective given in the neutral pole (i.e.) neutral is only switched but has no protective element incorporated.

TPN for Y (or star) the connection between ground and neutral is in many countries not allowed. Therefore the N is also switches.

Application: Three Phase Supply with Neutral

5. 4 Pole MCB:

4pole MCCB for 4 wires connections, the one additional 4th pole for neutral wire connection so that between neutral and any of the other three will supply.

In 4-Pole MCCBs the neutral pole is also having protective release as in the phase poles.

Application: Three Phase Supply with Neutral

2. Rules of Safety of Electricity

Rule no. 1

Avoid contact with energized electrical circuits. Please don't make fun of this rule if you already know this (and you probably already know if you are reading these lines) and remember that if something bad occurs – you probably won't have second chance. That's not funny.

Rule no. 2

Treat all electrical devices as if they are live or energized. You never know.

Rule no. 3

Disconnect the power source before servicing or repairing electrical equipment.

The only way to be sure.

Rule no. 4

Use only tools and equipment with non-conducting handles when working on electrical devices.

Easy to check.

Rule no. 5

Never use metallic pencils or rulers, or wear rings or metal watchbands when working with electrical equipment. This rule is very easy to forget, especially when you are showing some electrical part pointing with metallic pencil.

Always be aware.

Rule no. 6

When it is necessary to handle equipment that is plugged in, be sure hands are dry and, when possible, wear nonconductive gloves, protective clothes and shoes with insulated soles.

Remember: gloves, clothes and shoes.



Safety clothes, gloves and shoes

Rule no. 7

If it is safe to do so, work with only one hand, keeping the other hand at your side or in your pocket, away from all conductive material. This precaution reduces the likelihood of accidents that result in current passing through the chest cavity.

If you ever read about current passing through human body you will know, so remember – work with one hand only.

If you don't clue about electric current path through human body, read more in following technical articles:

- Do You Understand What Is Electric Shock?
- What psychological effect does an electric shock?

Rule no. 8

Minimize the use of electrical equipment in cold rooms or other areas where condensation is likely. If equipment must be used in such areas, mount the equipment on a wall or vertical panel.

Rule no. 9

If water or a chemical is spilled onto equipment, shut off power at the main switch or circuit breaker and unplug the equipment.

Very logical. NEVER try to remove water or similar from equipment while energized. After all, it's stupid to do so.

Rule no. 10

If an individual comes in contact with a live electrical conductor, do not touch the equipment, cord or person. Disconnect the power source from the circuit breaker or pull out the plug using a leather belt.

Tricky situation and you must be very calm in order not to make the situation even worse.

Like in previous rules – Always disconnect the power FIRST.



Always disconnect the power FIRST

Rule no. 11

Equipment producing a “tingle” should be disconnected and reported promptly for repair.

Rule no. 12

Do not rely on grounding to mask a defective circuit nor attempt to correct a fault by insertion of another fuse or breaker, particularly one of larger capacity.

Rule no. 13

Drain capacitors before working near them and keep the short circuit on the terminals during the work to prevent electrical shock.

Rule no. 14

Never touch another person's equipment or electrical control devices unless instructed to do so.

Don't be too smart. Don't try your luck.

Rule no. 15

Enclose all electric contacts and conductors so that no one can accidentally come into contact with them.

If applicable do it always, if not be very carefully.

Rule no. 16

Never handle electrical equipment when hands, feet, or body are wet or perspiring, or when standing on a wet floor.

Remember: Gloves and shoes

Rule no. 17

When it is necessary to touch electrical equipment (for example, when checking for overheated motors), use the back of the hand. Thus, if accidental shock were to cause muscular contraction, you would not "freeze" to the conductor.

Rule no. 18

Do not store highly flammable liquids near electrical equipment.

Rule no. 19

Be aware that interlocks on equipment disconnect the high voltage source when a cabinet door is open but power for control circuits may remain on.

Read the single line diagram and wiring schemes – know your switchboard.

Rule no. 20

De-energize open experimental circuits and equipment to be left unattended.

Rule no. 21

Do not wear loose clothing or ties near electrical equipment. Act like an electrical engineer, you are not on the beach.

Electrical Devices

1. Single way
2. Tumbler socket (15 Amp)
3. Single way (tumbler switch)
4. Tumbler socket
5. Pendent Holder
6. Batten Holder
7. Angle Batten Holder
8. Piano Socket
9. Piano Switch 15 Amp
10. Piano Type (Bed Switch)
11. Push Switch
12. Tube Light Holder (spring side)
13. Tube Light Holder (star side)
14. Ballast
15. Piano 40 watt 5 Amp two way switch
16. Piano Type cut out 10 Amp
17. Fuse
18. Push Batten Switch // surface bell push
19. On//Off switch
20. Two way On//Off switch
21. Tube Light Starter
22. Three Phase Circuit
23. Magnetic Starter
24. Thermal Overload Relay
25. Single phase circuit
26. Two piano round plug (5Amp) PVC
27. Three piano round plug
28. Ceiling Rose 5 Amp
29. Three Way circular base
30. Single Way circular base
31. Bend ($\frac{3}{4}$)
32. Elbow ($\frac{3}{4}$)
33. Three Bend
34. PVC conduit
35. PVC Socket
36. Shaded Lamp
37. Run Capacitor
38. Start Capacitor
39. Ampere Meter
40. Volt Meter
41. Aconite Switch
- 42.

Electrical Tools

1. Flat file
2. Half round file
3. Grip vice
4. Triangular file
5. Square file
6. Round file
7. Hack Saw frame with blade
8. Measuring tap // steel tap
9. File brush
10. Helmet
11. Wooden saw
12. Neon tester
13. Earth tester
14. Allen key
15. Safety belt
16. Hand Gloves
17. Hand drill machine
18. Drift punch
19. Centre punch
20. Pin punch
21. Divider
22. Try Square
23. Outside chipper
24. Centre punch
25. Steel punch
26. Crimping pliers
27. Cable cutter
28. Wire stripper
29. Insulation cutter
30. Combination pliers
31. cutting pliers
32. Long pliers
33. Outside micrometer
34. Twist drill bit
35. Flat screw driver
36. Connecting Screw driver
37. Connecting screw driver
38. Inside circlip opener
39. Clamp
40. Electric Hand drill machine
41. Venire chipper
42. Nail plugging pliers
43. Flat chisel
44. Wooden chisel
45. Triangular chipper
46. Claw hammer
47. Ball peen hammer
48. Open and spanner
49. Combination spanner
50. Adjustable spanner
51. Hand grinding machine
52. Safety goggles
53. mucks
54. pulley puller
55. Scissors
56. Soldering iron
57. Sucker
58. Try Square
59. Plastic Hammer or soft
60. Cross peen hammer

|| 5 || Electrical Wire Joints

1. Splice Joints
2. Married Joints
3. Tape Joints
4. Turn Joints
5. Splice Joints
6. Britannia Joints
7. Tape Joint get
8. Bell hanger Joints
9. Britannia tape Joints
10. Double Cross Joints
11. Pig tail Joints
12. Western union joints



|| 6 || Electrical Surface wiring

Electrical wiring is generally refers to insulated conductor used to carry current and associated device. This article describes general aspects of electrical wiring as used to provide power in buildings and structures, commonly referred to as building wiring

1. Cleat wiring
2. Cross wiring
3. Conduit wiring
4. Batten wiring
5. Channel wiring
6. Hook wiring

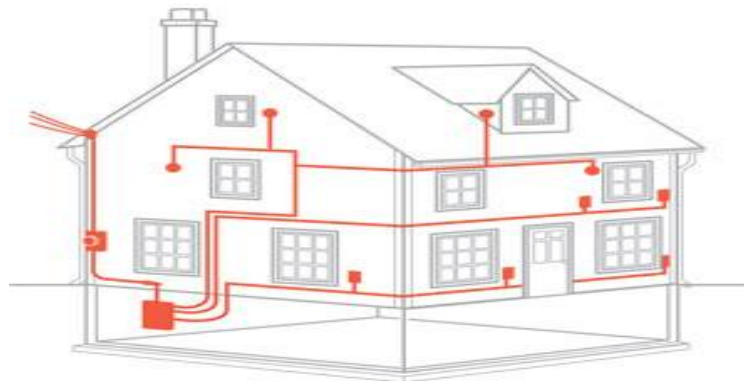

|| 7 || PVC Cables

1. PVC (4 core flexible round cable) 4 x 70 x 0.0076
2. PVC (4 core flexible round cable) 4 x 40 / 0.0076
3. PVC (5 core flexible round cable) 5 x 70 / 0.0076
4. PVC (3 single strand double insulated cable)
5. PVC (2 core flat cable) 2 x 7 / 0.036
6. PVC (2 core flat cable) 2 x 3 / 0.029
7. PVC (3 single core cable) 1 x 3 / 0.029
8. PVC (single core cable) 1 x 7 / 0.036
9. PVC (single core cable) 1 x 3 / 0.036
10. PVC (single core single strand cable 18 SWG)



"PVC Polyvinyl chloride, more correctly but unusually poly (vinyl chloride),

Commonly abbreviated PVC is the third-most widely produced synthetic plastic polymer, after polyethylene and polypropylene.

PVC comes in two basic forms: rigid (sometimes abbreviated as RPVC) and flexible. The rigid form of PVC is used in construction for pipe and in profile applications such as doors and windows. It is also used for bottles, other non-food packaging, and cards (such as bank or membership cards). It can be made softer and more flexible by the addition of plasticizers, the most widely used being phthalates. In this form, it is also used in plumbing, electrical cable insulation, imitation leather, signage, inflatable products, and many applications where it replaces rubber.

Pure poly (vinyl chloride) is a white, brittle solid. It is insoluble in alcohol but slightly soluble in tetrahydrofuran.

Electrical tape (or **insulating tape**) is a type of **pressure-sensitive** tape used to insulate electrical wires and other materials that conduct electricity. It can be made of many plastics, but **vinyl** is most popular, as it stretches well and gives an effective and long lasting insulation.



|| 8 || Switches

Switches:

In electrical and electronic system, a switch is a device, which can make or break an electrical circuit or we can say that switch is a controlling device, which interrupt the flow of current or direct the flow of current in another direction. Almost all the electrical and electronics systems contain at least one switch, which is used to make the device ON or OFF. In addition, a switch is used to control the circuit operation and user may able to activate or deactivate the whole or certain parts of the connected circuit.

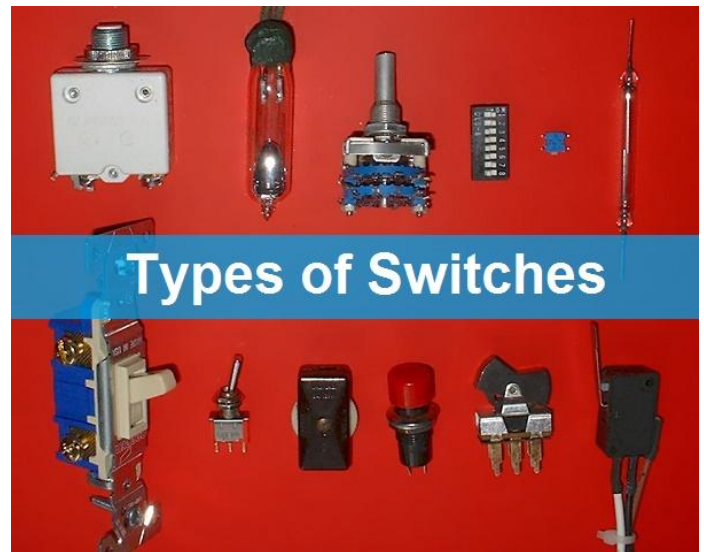

Generally, Switches can be categories as.

- 1) Mechanical Switches
- 2) Electrical/Electronic Switches

Mechanical Switches:

Mechanical switch is a switch in which two metal plates touch each other to make a physical contact for the current to flow and separate from each other to interrupt the flow of current. There are many types of Mechanical switches and they are also being categories on the basis of power handling capacity. The contact material is chosen by keeping in mind that the metal oxides, which produced due to corrosion, are mostly insulator and layers of such oxides on the switch plates will hinder the normal operation of the switch.

Mechanical Switches can be categorized on the basis of their operation:

SPST (Single Pole Single Throw)

This is a simple ON/OFF switch. It is also called as On Way Switch (in the US, they called it Two-Way Switch). When a user press the button of the switch, then the plates of the switch connect with each other and the current starts to flow and vice versa.



SPDT (Single Pole Double Throw)

This button has three pins in which, one pin is used as common and called a Two-Way Switch (in US, they called it Three-Way Switch). We can send two different signals to same pin by using this switch. Because of this functionality, this switch is also called selector switch.

Other switches related to SPDT are SPCO (Single Pole Changeover) and SPTT (Single Pole Center Off or Single Pole Triple Throw)

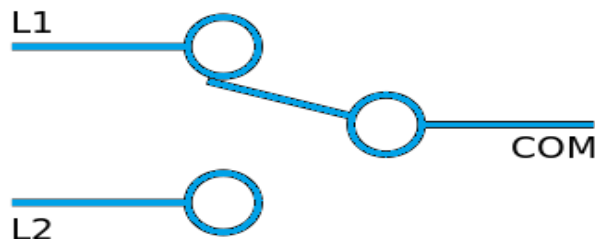

DPST (Double Pole, Single Throw)

This switch is basically two SPST switches in one package and can be operated by a single lever. This switch is mostly used, where we have to break both ground and lines at the same time.

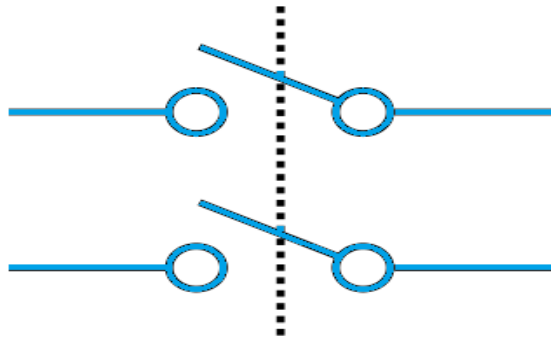

DPDT (Double Pole Double Throw)

This switch is equivalent to two SPDT switches packaged in one pack. This switch has two common pins and four signal pins. Total four different combinations of singles can be applied to the input pins of this switch. Another switch, related to DPDT is **DPCO** (Double Pole Changeover or Double Pole, Centre Off).

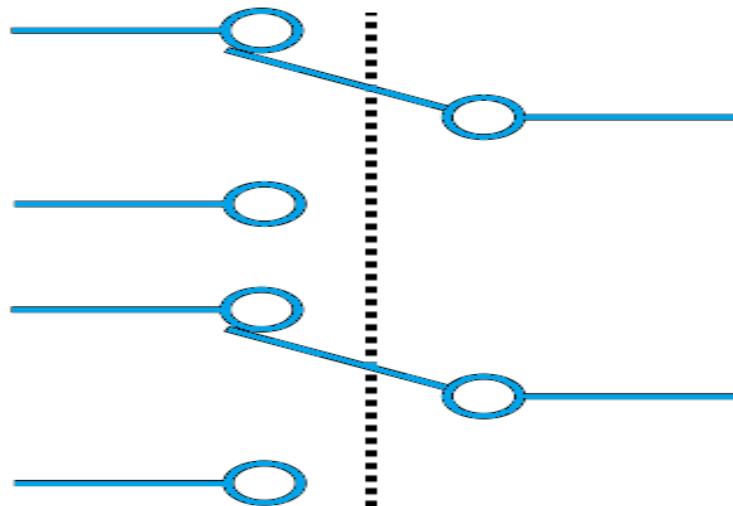

2P6T (Two Pole, Six Throw)

It is a type of the changeover switch with a common (COM) which may be connected to six lines with a second two pole switch, which controlling and the operation of the switch is same.

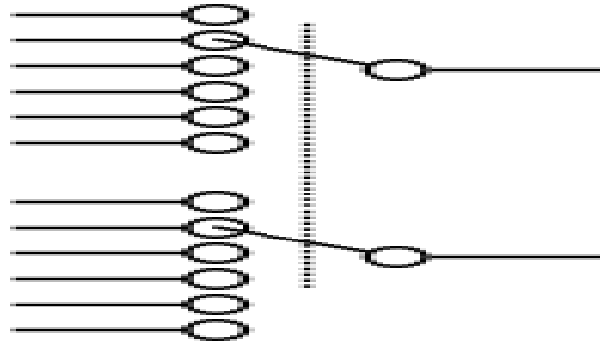

What is Intermediate switch, its construction and how it works?

There are four terminals in intermediate switch by which it changes the flowing of current from one circuit to another circuit (fig1). It's ON and OFF the supply by two ways. The four terminals of intermediate switch is shown in fig 1 label as A, B, C, D. In some cases, the terminal contacts of switch is meet terminal A with terminal C and terminal B meet with terminal D as shown in fig 1 a.

Intermediate Switch

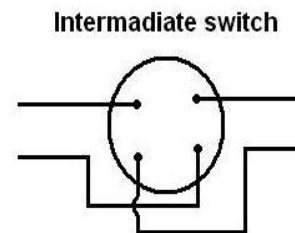

Fig 1
Intermediate Switch

Elctricaltechnology1.blogspot.com

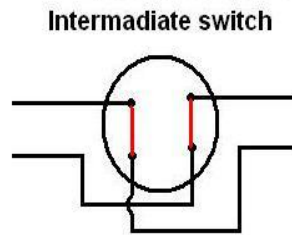

Fig 1a.
At postion 1, when knob of the intermatiate switch is UP

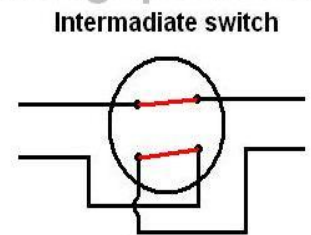

Fig 1b.
At postion 2, when knob of the intermatiate switch is DOWN

Elctricaltechnology1.blogspot.com

In other cases , the terminal contacts of switch is meet terminal A with terminal B and terminal C meet with terminal D as shown in fig 1 b.

When the knob of the switch is UP, then the vertical contacts are meeting (i.e. AC and BD as shown in fig 1a). And when the knob is DOWN, then the Horizontal contacts are meeting (i.e. AB and CD as shown in fig 1b).

Application and Uses

This kind of switch is used in a hall, big rooms or Go down where different lamps are require to ON/OFF from different places. Moreover, in a multistory building, the lamp at ground floor, in car parking shade can be controlled or ON / OFF from any floor by using intermediate switch circuit.

In Fig 2, a lamp is controlled from three different places by using two, 2-way switches and one intermediate switch.

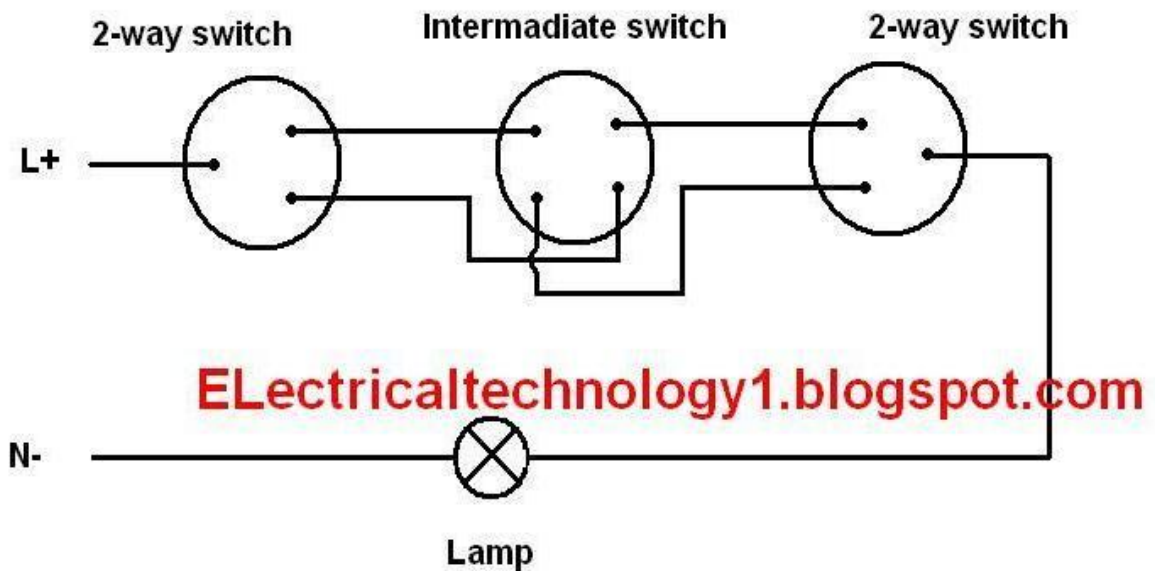

A Lamp is switched ON and switched OFF from three different places.

In fig 3, a lamp is controlled from six different places by using two, 2-way switches and four intermediate switches.

How to control one lamp from six different places by using two, 2-way switches and four intermediate switches.

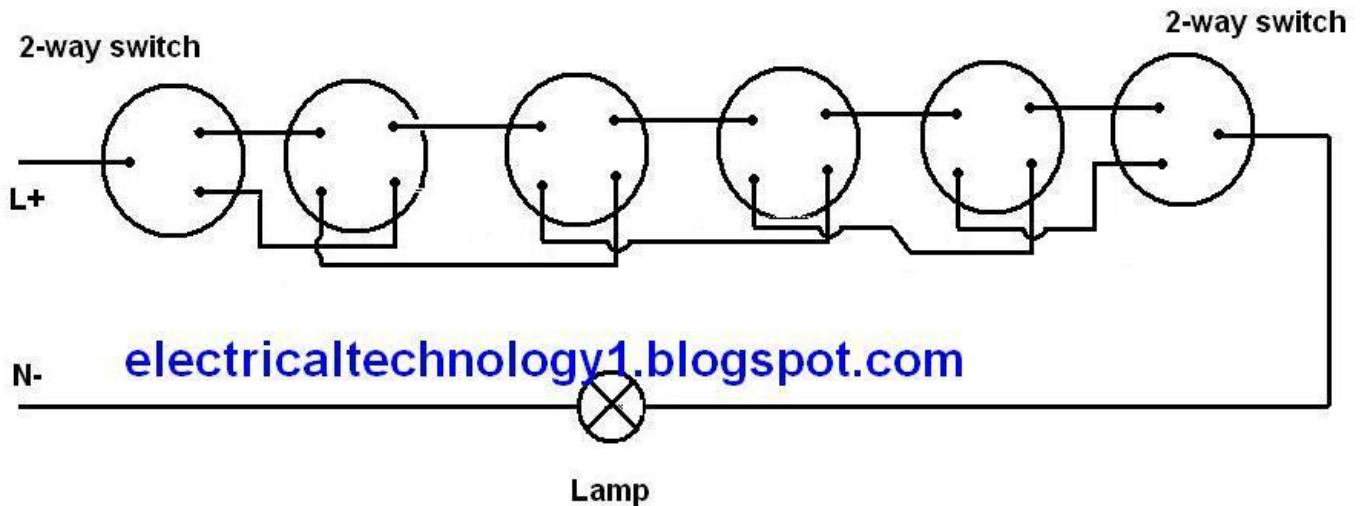

A lamp is controlled from six different places by using two, 2-way and four intermediate switches.

Key Point: You can control a lamp from many different places by adding more intermediate switches.

Electrical and Electronic Switches:

The Above discussed switches are Mechanical switches and they are user manually operated. Now, we are going to discuss Electrical switches, which are faster in response than mechanical switches and can be switched automatically by an electronic circuit like microcontroller or microprocessor.

They can also be categories on the basis of current and voltage rating like mechanical switches.

There are the most widely used electronic switches.

1) Transistor 2) Mosfets 3) Relays

1. Transistor:-

Transistor can be used in different mode of operation but we are going to discuss the transistor as a switch. If we apply a large amount of current at the base of the transistor (keeping in mind the maximum allowed current for the this type of transistor) then we can run this transistor in deep saturation mode

2. Mosfets:-

Mosfet can also be used for switching purpose at high frequencies. They can operate at Mega hertz frequencies. Mostly, Mosfets used for PWM (pulse width modulation).

Mosfets have three terminals.

- 1) Gate
- 2) Drain
- 3) Source

3. Relays:-

A Relay is an electromechanical device, which consists of an electromagnet. When a current is flowing through the coil, it becomes an electromagnet and this electromagnet can be used for switching purposes. Their contacts can fall into any category, e.g. SPDT, DPDT etc.

|| 9 || Electrical Measurements

Voltage sources

Batteries and other voltage sources have **internal resistance**. When they do work moving charges against the electric force, some of this work is already converted to thermal energy in the battery. The amount of energy lost to thermal energy in the battery is Ir , where I is the current flowing in the circuit and r is the internal resistance of the battery. The voltage across the battery terminals therefore drops from the nominal value V to $(V - Ir)$ when a current is flowing in the circuit. In a circuit diagram we represent the internal resistance of the battery by a resistor r connected in series with the emf.

A voltmeter is a device used to measure voltages, while an ammeter measures currents. Meters are either analog or digital devices. Analog meters show the output on a scale with a needle, while digital devices produce a digital readout. Analog voltmeters and ammeters are both based on a device called a galvanometer. Digital voltmeters and ammeters generally determine the **voltage drop across a known resistor** and then convert the result to a digital value for display.

Voltmeters

Resistors in parallel have the same voltage across them. If you want to measure the voltage across a circuit element, such as a resistor, you place the voltmeter in parallel with the resistor. The voltmeter is shown in a circuit diagram as a V in a circle, and it acts as another resistor. To prevent the voltmeter from changing the current in the circuit (and therefore the voltage across the resistor),

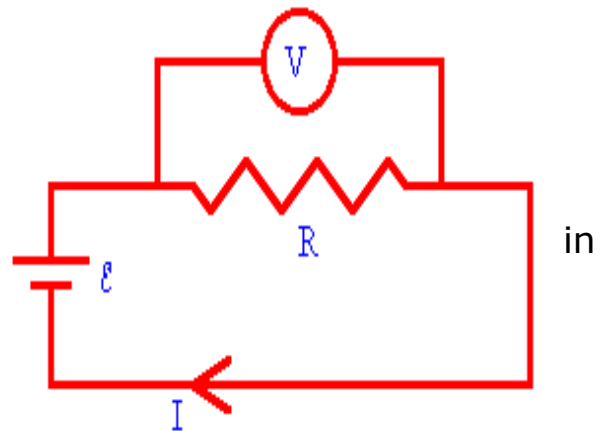

The voltmeter must have a resistance much larger than that of the resistor. If the resistance of the voltmeter is large, only a negligible current flows through the meter.

Ammeters

Resistors in series have the same current flowing through them. An ammeter must be placed in series with a resistor to measure the current through the resistor. On a circuit diagram, an ammeter is shown as an A in a circle. The ammeter acts as a resistor. To prevent the ammeter from changing the current in the circuit,

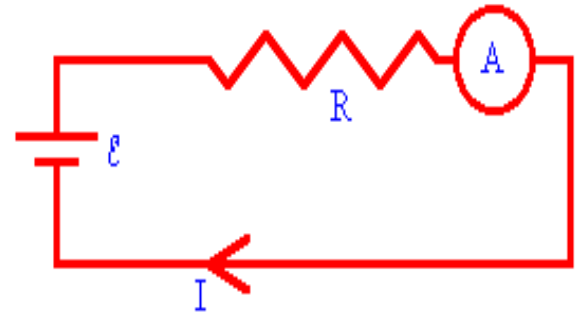

The ammeter must have a very small resistance compared to the resistance R of the circuit.



So now I am going to provide you some connections as a word and then you will try to connect about these connections. Already you are given answer of question one so they are 50 questions.

1. Connect one bulb by one switch (AC)?
2. Connect two bulbs by two switches as a parallel (AC)?
3. Connect three bulbs by three switches as a parallel (AC)?
4. Connect one switch and three bulbs by series connection (AC)?
5. Connect one switch with two bulbs by parallel (AC)?
6. Connect three bulbs with one switch by parallel (AC)?
7. Connect two switches with one bulb and socket by parallel (AC)?
8. Connect two bulbs with one switch by series connection (AC)?
9. Connect one bulb with one switch, two parallel bulbs with one switch two series bulbs with one switch and 5 amp two pin socket with one switch (AC)?
10. Connect two series and three parallel bulbs connection by one switch (if one of series bulbs out from the batten holder parallel bulbs will off) (AC)?
11. Connect two series and three parallel bulbs with one switch (if one series bulb out from batten holder the other parallel bulbs will not off) (AC)?
12. Connect one ceiling fan with one switch (AC)?
13. Connect one bulb with one switch, three series and three parallel bulbs with one switch, two ceiling fan with two switch, one two pin socket with one switch (AC)?

14. Connect one bulb with one switch, two ceiling fan with one switch, 2(two pin socket) with one switches (AC)?
15. Connect one calling bell controlled with one push switch (AC)?
16. Connect one calling bell controlled with two push switch by series (AC)?
17. Connect one calling bell controlled with two push switch by parallel and difference watt of bulbs (AC)?
18. Connect one calling bell controlled with three push switch by parallel and difference watt of bulbs (AC)?
19. Connect one calling bell controlled with four push switch by parallel and difference watt of bulbs (AC)?
20. Connect one bulb with one switch, two parallel bulbs with one switch, three series bulbs with one switch, two ceiling fan with one switch, two sockets pin with one switch and one calling bell with one switch (AC)?
21. Connect one gang one way switch with two bulbs of parallel (AC)?
22. Connect two gangs one way switch with two bulbs of parallel (AC)?
23. Connect three gangs one way switch with three bulbs of parallel (AC)?
24. Connect four gangs one way switch with four bulbs of parallel (AC)?
25. Connect five gangs one way switch with five bulbs of parallel (AC)?
26. Connect one gang one way switch with two pin socket (AC)?
27. Connect one gang one way switch with one ceiling fan (AC)?
28. Connect one bulb with two way switch by series connection (AC)?
29. Connect one bulb controlled from three places by using two way and intermediate switch (AC)?
30. Connect one bulb controlled from four places by using two way and two intermediate switch (AC)?
31. Connect two bulbs with one switch by parallel and two bulbs controlled from two places by parallel (AC)?
32. Connect 15 Amp socket with 15 Amp switch and circuit breaker (AC)?
33. Connect one six pin combined with circuit breaker (AC)?
34. Connect one six pin combined and indicator lamp with circuit breaker (AC)?
35. Connect one bulb with one switch, one ceiling fan with one switch, one calling bell with one switch, one templar socket 5 Amp with one switch, one templar socket 15 Amp with templar switch to operate by water pumps, one six pin combined with circuit breaker to operate one fridge (AC)?
36. Connect one tube light with one switch (AC)?
37. Connect one tube light with one switch and one bed switch (AC)?
38. Connect one bulb that will difference bright once high and once low by using capacitor (AC)?
39. Connect 15 Amp socket with 15 Amp switch and with two separate circuit breaker (AC)?
40. Connect to test lamp with switch series circuit board (or make series circuit board by one switch) (AC)?
41. Connect series with parallel circuit board by one switch (AC)?

42. Connect series lamp for working two phase line (AC)?
43. Connect two bulbs with two switches separately, two ceiling fan with two switches, two series bulbs with one switch, three parallel bulbs with one switch, one bulb controlled from two places, two difference bright of light with one switch, one tube light with bed switch by one switch, one calling bell will ring from two places, two 5 Amp socket with one switch, one six pin combined socket to operate refrigeration, 15 Amp socket connection to operate water pump (AC)?
44. Connect one voltmeter by single phase line by using always parallel connection (AC)?
45. Connect one Ammeter by single phase line by using always series connection (AC)?
46. Connect one Voltmeter and one Ammeter connection by in single phase line (AC)?
47. Connect three Voltmeter by three phase line (440 watt) (AC)?
48. Connect three Voltmeter by three phases with one line (220 watt) (AC)?
49. Connect three Voltmeter and three Ammeter connections by in three phases line (440 watt) (AC)?
50. Connect two bulbs with one switch separately, one bulb two difference bright of lighting, two series and two parallel bulbs controlled from one place, one ceiling fan with one 2 pin socket, one tube light with one switch, one calling bell controlled from two places to operate one fridge and one water pump connect by power socket with all types of devices (AC)?

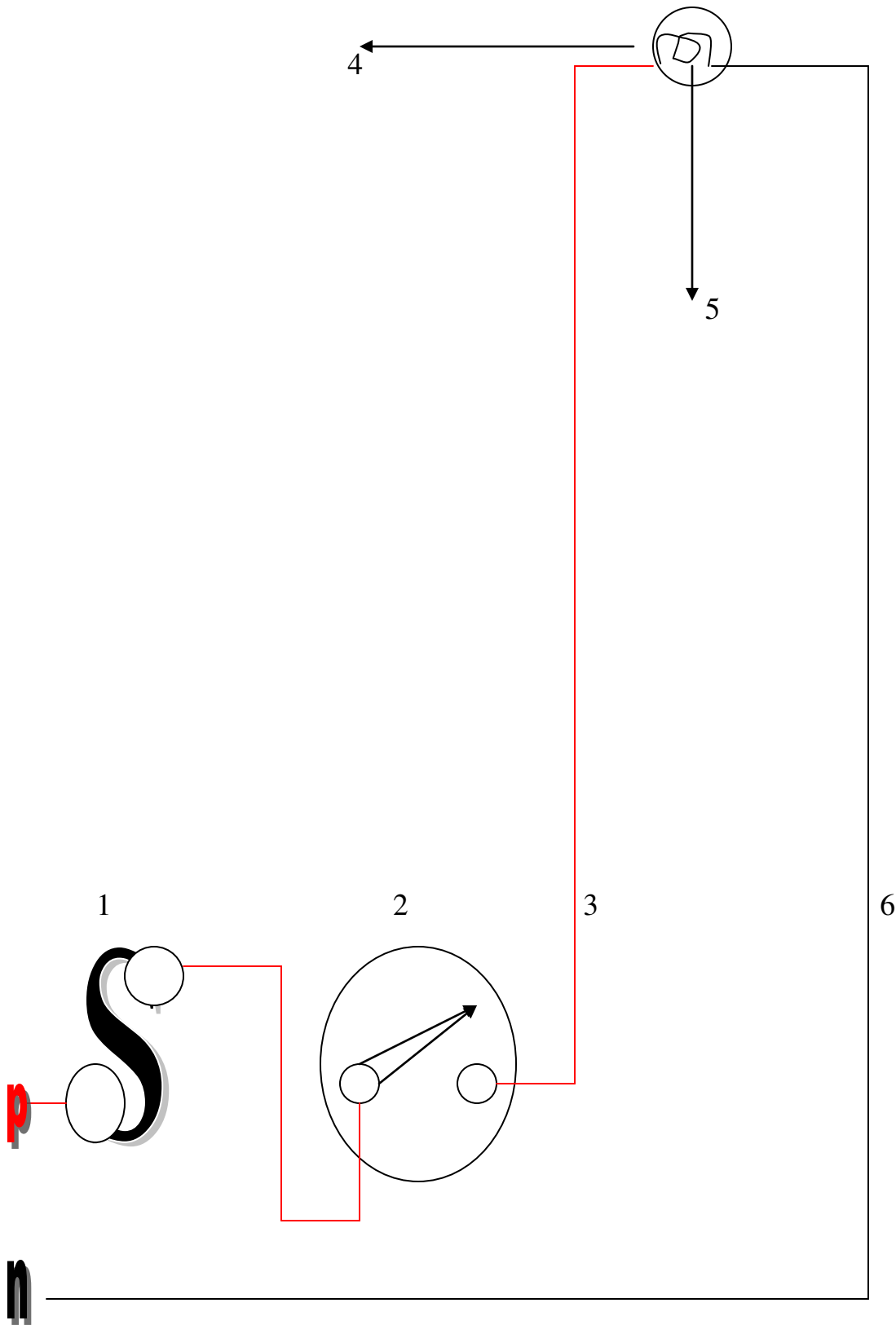

1. Piano fuse
2. Piano switch
3. Red wire (phase)
4. Batten holder
5. Bulb
6. Black wire (neutral)